



Latest online doc version

Wirnet™ iZeptoCell Cellular

LoRaWAN® gateway for the Internet of Things

Quick Start Guide



Thank you for choosing Kerlink.

We are proud to be part of your project.



KLK03549_01
Kerlink internal use only

1 Need help?

The Wirnet™ iZeptoCell is an indoor LoRa Gateway for IoT chain. It is based on LoRa® technology provided by Semtech Company and is fully compatible and interoperable with existing LoRa LPWAN.



Upon specific configuration, Wirnet™ iZeptoCell can be used as a Helium-network compatible hotspot to mine HNT. To do so, it needs to be clearly mentioned once ordered as it uses a specific cryptographic private key, a dedicated software, and Helium miner. If you have any doubt, please check directly with your reseller to ensure it is Helium-network compatible. For Helium-network onboarding, please go through Helium application or use <https://helium-onboarding.kerlink.com/>

- In order to provide the most updated technical documentation, as well as considering and saving the environmental resources, Kerlink is providing preferably “Online documentation”.
- For its direct customers, Kerlink is also providing a Wiki access where it can be found a comprehensive set of documents and technical information. It can be accessed here: <http://wikikerlink.fr/>
 - If you don't have yet your Wiki login/password, please request them to support@kerlink.com (note that the “EUI” of one of your products will be required).
 - How to find the EUI? Please look at the Wirnet iZeptoCell sticker placed on the top side of the case and scan the QR code.



- For Kerlink Helium Hotspots customers, a public wiki page provides all relevant information about setup, onboarding, and troubleshooting. It can be accessed at: <https://wikikerlink.fr/helium>
- For any Warranty or Maintenance related request (Trouble shooting, help ...)
 - If purchased from a Distributor, please contact the distributor directly for Level1 support. If purchased from Kerlink directly, please open an “Assistance Request” via our ticketing tool called OTRS (Open-source Ticket Request System)
 - If you don't have yet your OTRS login/password, please request them to support@kerlink.com (note that the Product Id or any serial number of one of your products will be required).
 - Access to Kerlink “Technical Support team” for Maintenance Services is conditioned to a valid Maintenance contract.
- For additional information or if you need any assistance to use the product, please contact your reseller. You can also find more information here: <https://www.kerlink.com/customer-support/>

2 Manufacturer

KERLINK

1 Rue Jacqueline Auriol
35235 Thorigné-Fouillard
France



Tel.: +33 (0)2 99 12 29 00 – Fax: +33 (0) 2 99 12 29 11

www.kerlink.com

3 Safety

Read these instructions carefully and look at the equipment to become familiar with the device before trying to install, operate, or maintain it.



The following special messages may appear throughout this documentation or on the equipment to warn of potential hazards or to call attention to information that clarifies or simplifies a procedure.

	Refers to a critical situation. In case of non-compliance, it may result in property damage.
	Refers to useful information during manipulations.

It is an integral part of the described equipment and it must be available at all time.

	<ul style="list-style-type: none"> • Only use the Wirnet iZeptoCell for its intended use "Normal conditions of use". • Maintenance and repair must be carried out by qualified personnel authorized by the manufacturer. • The enclosure of the Wirnet™ iZeptoCell must not be opened by CUSTOMER. • The Wirnet iZeptoCell should only be used with accessories or spare parts supplied by your reseller.
---	---





4 Package Contents

Item	Wirnet iZeptoCell	Parts
1	This document...	Quick start guide
2		x1 Wirnet iZeptoCell
3		x1 Multi-blades power supply (North America, Europe, United Kingdom)
4		x1 USB-A cable extender

Kerlink could also provide the following accessories:

Optional		1x USB-A to USB-C cable
----------	---	-------------------------

5 Markings

Symbol	Description	Symbol	Description
Wirnet iZepToCell	Type of equipment	IP30	Ingress protection level
PDTIOT- IZECxxx	Reference of equipment	CE or other marking	CE marking indicating that the product complies with current European directives or other marking depending on the country
EUI	Extended unique identifier	RoHS	Marking indicating that the product complies with RoHS directives
	QR code (EUI)		Do not dispose of with domestic waste
5V  1.5A	Power supply information		Product must be installed on a non-flammable substrate (UL94V0). Refer to the installation instructions before powering up

6 Casing description

6.1 Casing dimensions

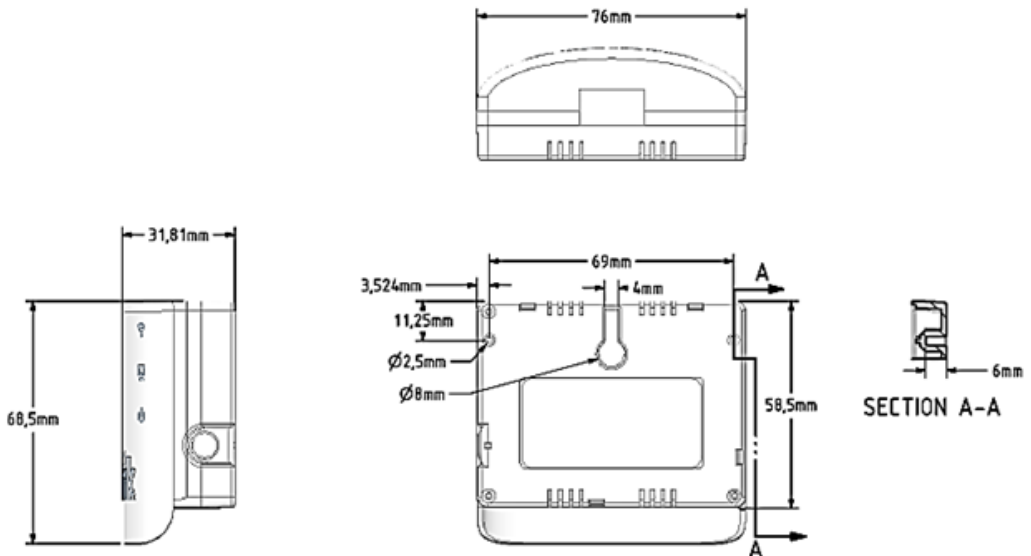

6.2 Casing wall fixing

Wall mounting is completed by using the oblong hole on the rear side.

A 4mm diameter screw (M4) with countersunk flat head and an appropriate wall plug are recommended.

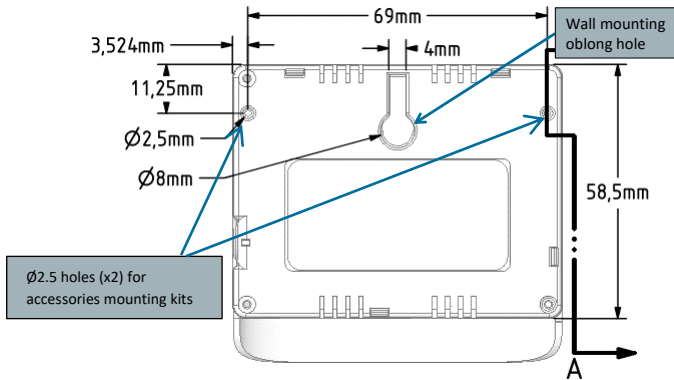

Two non-threaded holes (2.5mm diameter, 6mm depth) could be also used for accessories mounting. Plastic screws with 3mm outside thread and 2.1mm core thread are recommended.

VELCRO stripes or double-sided adhesives foams could be also used for easy wall mounting.

Two parts of 25mmx17mm are recommended on both side of the oblong hole as detailed below:

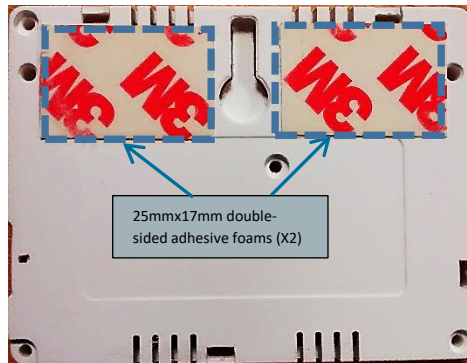

7 Setting Connections



To allow the good working of ZTP (Zero Touch Provisioning), please ensure sufficient LTE CatM, LTE Cat NB2 or GPRS cellular network coverage before powering up the product.

2 possible modes of connection are possible:

7.1 Power supply through multi-blade wall adapter

ID	Connections possibilities	Comments
1		Power supply via the multi-blade adapter

7.2 Power supply through USB cable

2		Power supply via USB
---	--	----------------------



8 Commissioning

8.1 LEDs

To ensure the Wirnet iZeptoCell is started up, check the behavior of the LED indicators:

Indicative timings:

- Boot takes around 1min 20s,
- Backhaul connection takes around 30s,
- SW reset takes around 2 min.

LED	Specification
 LED 3: LoRa® RF activity (Uplink, Downlink)	<ul style="list-style-type: none">• Boot -> Red Fix ON• LoRa Data Reception (Uplink) -> GREEN Blink• LoRa Data Emission (Downlink) -> RED Blink
 LED 2: Backhaul status	<ul style="list-style-type: none">• Backhaul is disconnected -> Red Fix ON• Backhaul connection -> GREEN Blink• Backhaul is connected -> GREEN Fix ON
 LED 1: Gateway status	<ul style="list-style-type: none">• Boot -> Red Blink• Normal mode -> Green Fix ON• Software Halt (Power down sequence) -> Red Blink• Software Update -> Red Blink



Applicative software means embedded software running on the Wirnet™ iZeptoCell like Kerlink « common » packet forwarder or any another Packet Forwarder (software that forwards LoRa packets received to a server).

Please contact your reseller to know the LEDs behavior if the applicative software installed on the Wirnet™ iZeptoCell is not the one officially provided by KERLINK.

8.2 Reset button

Short press the “Reset” button (<5s) to generate a software reset of the product. See LEDs behaviors in the dedicated LEDs table.

Long press the “Reset” button (>5s) to halt the software of the gateway during 2mn. All LEDs are switched off in this state. This action is preconized before removing power supply to avoid any risk to alter memory. The gateway is then reset after 2mn (back to normal functioning).



9 Connection to the gateway

9.1 Security

To prevent Web robots to attack the gateway with standard login/password such as root/root, Kerlink setup default public password, built using the last 6 digits of the EUI.

For example, if the EUI is 7076FFyyz020001 then the root password will be pdmk-020001 (case sensitive). On WMP, for the gateway klk-zcel-020001, select Remote Access / Shell

- login: root
- Password: pdmk-020001

This 6-digit number can also be retrieved in the hostname. It is displayed in the shell prompt.

For security reasons, the customer must change the default public password to a specific hardened one.

This can be completed via the Wanesy Management Plan.

If the gateway is planned to be used for Helium-network, then no SSH access can be given due to the cryptographic key and to ensure Kerlink Helium Hotspot integrity and security.

9.2 Connection via Wanesy Management Plan interface (centralized administration)

Kerlink recommends the usage of WMP to access to the Administration and Management features of the gateway.

Indeed, this interface allows easy gateway management:

- Get status of the gateway
- Alarms
- Trigger software upgrade/update
- Configure backhaul connectivity
- Launch SSH connection
- Execute predefined set of commands (workflow)

Note that URL to Wanesy management Plan and Credential will be given by Kerlink via email.

9.3 Connection via the web interface of the gateway (local administration)

The Wirnet product line also embeds a web interface to manage the gateways.

The generic syntax to access to this web interface is: `http://klk-zcel-<serial>/`

This means for the gateway EUI is 7076FFyyz020001: `http://klk-zcel-020001/`

The default public credentials are:

- Login: admin
- Password: pwd4admin

For security reasons, the customer must change the default public password to a specific hardened one.

10 Additional information

For direct customers, consult the Kerlink Wiki: www.wikikerlink.fr

For Kerlink Helium Hotspots customers, consult the public wiki page at: <https://wikikerlink.fr/helium>

11 Conformity

	<p>Radio equipment shall be put into service and used only when granted a certificate, type approval, etc. according to the national regulation. They shall be properly installed, maintained, and used for its intended purpose. Economic operators shall ensure effective and efficient use of the radio spectrum, avoidance of harmful interference, electromagnetic disturbances or to public health.</p> <p>Penalties may lay down applicable to infringements by economic operators of the provisions of national law adopted and they shall take all measures necessary to ensure that they are enforced. Such rules may include criminal penalties for serious infringements.</p>
---	---

 Information	The operating temperature range of the Wirnet™ iZeptoCell is 0°C to +55°C.
--	--

11.1 Wirnet™ iZeptoCell PDTIOT-IZEC800

Simplified EU Declaration of Conformity



Hereby, Kerlink, declares that the radio equipment type Wirnet™ iZeptoCell PDTIOT-IZEC800 is compliant to Directive 2014/53/EU.

The full text of the EU Declaration of Conformity is available at the following internet address:
<https://www.kerlink.com/customer-support/support-wirnet-izeptocell-cellular/>

In Europe, the Wirnet™ iZeptoCell PDTIOT-IZEC800 gateway must comply with the ERC 70-03 requirements regarding duty cycle and maximum EIRP. They are summarized in the following table:

ERC 70-03	Frequency (MHz)	Power	Duty Cycle
h1.4	865-868	14dBm ERP	1%
h1.5	868-868,6	14dBm ERP	1%
h1.7	869,4-869,65	27dBm ERP	10%

 Information	<p>The power supply of the Wirnet™ iZeptoCell PDTIOT-IZEC800 must be a limited source of power. Note that: If the LoRa antenna is changed, the output power must be adjusted to consider the gain of the antenna in order to not overrule the ERC 70-03 recommendation. Some countries in Europe may have specific frequency ranges, EIRP and duty cycles regulations. Check the local regulations before installing and commissioning the Wirnet™ iZeptoCell PDTIOT-IZEC800.</p> <p>For other countries, outside Europe, check the frequency range, the maximum EIRP and duty cycle allowed.</p>
--	---



 	Band h1.4 cannot be used in the following countries: Sweden (SE).
--	---

11.2 Wirnet™ iZeptoCell PDTIOT-IZEC900

The Wirnet™ iZeptoCell PDTIOT-IZEC900 is compliant with both FCC and IC regulations. The associated FCC and IC identifiers of the Wirnet™ iZeptoCell PDTIOT-IZEC900 are:

Model: Wirnet™ iZeptoCell
 FCC ID: 2AFYS-KLKZEC900
 IC: 20637-KLKZEC900

Model: ME310G1-WW
 Contains FCC ID: RI7ME310G1WW
 Contient IC: 5131A- ME310G1WW

 <p>Information</p>	<p>The power supply of the Wirnet™ iZeptoCell PDTIOT-IZEC900 must be a limited source of power. Note that: Any change or modification of this equipment not expressly authorized by Kerlink may cause, interference and void the FCC authorization to operate this equipment. This device complies with Industry Canada’s license-exempt RSSs. Operation is subject to the following two conditions:</p> <ol style="list-style-type: none"> 1. This device may not cause harmful interference, and 2. This device must accept any interference received, including interference that may cause undesired operation of the device.
 <p>Information</p>	<p>Some conditions have to be respected to maintain the FCC and IC compliance of the devices in the USA and Canada. Please contact your reseller to have details. For other countries, check the specific regulations regarding maximum EIRP and duty cycle allowed.</p>
 <p>Information</p>	<p>This equipment has been tested and found to comply with the limits for a Class B digital device, pursuant to part 15 of the FCC Rules. These limits are designed to provide reasonable protection against harmful interference in a residential installation. This equipment generates, uses and can radiate radio frequency energy and, if not installed and used in accordance with the instructions, may cause harmful interference to radio communications. However, there is no guarantee that interference will not occur in a particular installation. If this equipment does cause harmful interference to radio or television reception, which can be determined by turning the equipment off and on, the user is encouraged to try to correct the interference by one or more of the following measures:</p> <ul style="list-style-type: none"> — Reorient or relocate the receiving antenna. — Increase the separation between the equipment and receiver. — Connect the equipment into an outlet on a circuit different from that to which the receiver is connected. — Consult the dealer or an experienced radio/TV technician for help <p>This radio transmitter 20637-KLKZEC900 has been approved by Innovation, Science and Economic Development Canada to operate with the antenna types listed below, with the maximum permissible gain indicated. Antenna types not included in this list that have a gain greater than the maximum gain indicated for any type listed are strictly prohibited for use with this device.</p> <p>Le présent émetteur radio 20637-KLKZEC900 a été approuvé par Innovation, Sciences et Développement économique Canada pour fonctionner avec les types d’antenne énumérés ci-dessous et ayant un gain admissible maximal. Les types d’antenne non inclus dans cette liste, et dont le gain est supérieur au gain maximal indiqué pour tout type figurant sur la liste, sont strictement interdits pour l’exploitation de l’émetteur.</p> <p>Internal antenna used: gain 2dBi dipole, 50 Ω, vertical, omnidirectional (Pulse W3012)</p> <p>This equipment complies with RSS102’s and FCC radiation exposure limits set forth for an uncontrolled environment under the following conditions:</p> <ol style="list-style-type: none"> 1. This equipment should be installed and operated such that a minimum separation distance of 20cm is maintained between the radiator (antenna) and user’s/nearby person’s body at all times. 2. This transmitter must not be co-located or operating in conjunction with any other antenna or transmitter. <p>Cet équipement est conforme aux limites d’expositions de la CNR102 applicables pour un environnement non contrôlé aux conditions suivantes:</p> <ol style="list-style-type: none"> 1. Cet équipement devra être installé et fonctionner de telle manière qu’une distance minimale de séparation de 20 cm soit maintenue entre la partie rayonnante (l’antenne) et l’utilisateur / les personnes à proximité à tout moment. 2. Cet émetteur ne doit pas être colocalisé ou opérer en conjonction avec toute autre antenne ou émetteur. <p>This device contains license-exempt transmitter(s)/receiver(s) that comply with Innovation, Science and Economic Development Canada’s license-exempt RSS(s). Operation is subject to the following two conditions:</p> <ol style="list-style-type: none"> 1. This device may not cause interference. 2. This device must accept any interference, including interference that may cause undesired operation of the device. <p>L’émetteur/récepteur exempt de licence contenu dans le présent appareil est conforme aux CNR d’Innovation, Sciences et Développement économique Canada applicables aux appareils radio exempts de licence. L’exploitation est autorisée aux deux conditions suivantes :</p> <ol style="list-style-type: none"> 1. L’appareil ne doit pas produire de brouillage; 2. L’appareil doit accepter tout brouillage radioélectrique subi, même si le brouillage est susceptible d’en compromettre le fonctionnement. <p>The operation of this equipment is subject to the following two conditions:</p> <ul style="list-style-type: none"> • (1) This equipment or device may not cause harmful interference, and • (2) This equipment or device must accept any interference, including that caused by its unwanted operation. <p>This equipment has been designed to operate with the antennas that are immediately listed and for a gain 3 dBi maximum antenna. The use with this equipment of antennas not included in this list or that have a gain greater than 3 dBi are prohibited. The required impedance of the antenna is 50 ohms.</p>

12 Disposal / recycling



Do not dispose of the product with household waste. For proper disposal, contact a waste disposal company.
The product packaging (cardboard and liners) can be removed with used paper.

13 Warranty

Contact your reseller for warranty conditions of the Wirnet iZeptoCell.



The Wirnet iZeptoCell is not warranted by Kerlink in case the enclosure is opened, modified, painted, branded out, outlined by CUSTOMER for any reason. Feel free to contact us for a guideline for the branding.

14 Accessories and Professional Services

For additional information, on available accessories and Professional Services please contact your reseller.

15 Give us your feedback

Your shopping and operational experiences are very important to us.
We would like to invite you to leave review on our products and services.
We will appreciate your time and efforts.
We would be very proud to get any photo of your gateway installation.
Could you please share them with us? dmk@kerlink.com



16 Find us in Social Media

We would like to hear from you: any tips, any news to share?



@kerlink_news



Kerlink



Kerlink channel

We stay at your disposal for any help on your project.

Yours sincerely,

Kerlink Team

